

## Intematix ChromaLit™ Linear *Remote Phosphor Light Source*

ChromaLit Linear enables new and creative designs for high lumen area and decorative lighting systems. Combining the benefits of remote phosphor with a unique delivery system, ChromaLit Linear delivers the uniform, glare free, color consistent lighting associated with remote phosphor systems with the additional benefit of a clean and familiar off state white appearance.

Unlike many linear LED solutions which may be limited to low lumen decorative lighting applications, ChromaLit Linear delivers the light density required to displace high wattage fluorescent tubes for commercial area lighting. The remote phosphor architecture reduces system costs and increases efficacy compared to conventional LED designs while delivering superior light quality and consistency. With extended lengths and future options to integrate optical elements to enhance beam control, ChromaLit Linear brings uniform glare free illumination to applications such as troffers, mid and high bay fixtures, cove lights, architectural lights, and task and under cabinet light fixtures.

### Product Features

- High flux density linear profile capable of up to 2500 lumens per foot with unlimited length possibilities
- Diffuse and uniform emission pattern
- Sleek profile with white exterior finish
- 3 SDCM color consistency
- Up to 30% higher system efficiency compared to white LED solutions
- CCT options from 2700K to 5000K with minimum 80 or 90 CRI

### Application Benefits

- Enables new design options for functional and decorative lighting applications
- Glare free non-pixelated lighting
- New shallow depth design potential
- Uniform consistent lighting
- Increased energy savings and lower total cost of ownership
- Supports broad market requirements for high quality lighting with improved inventory management

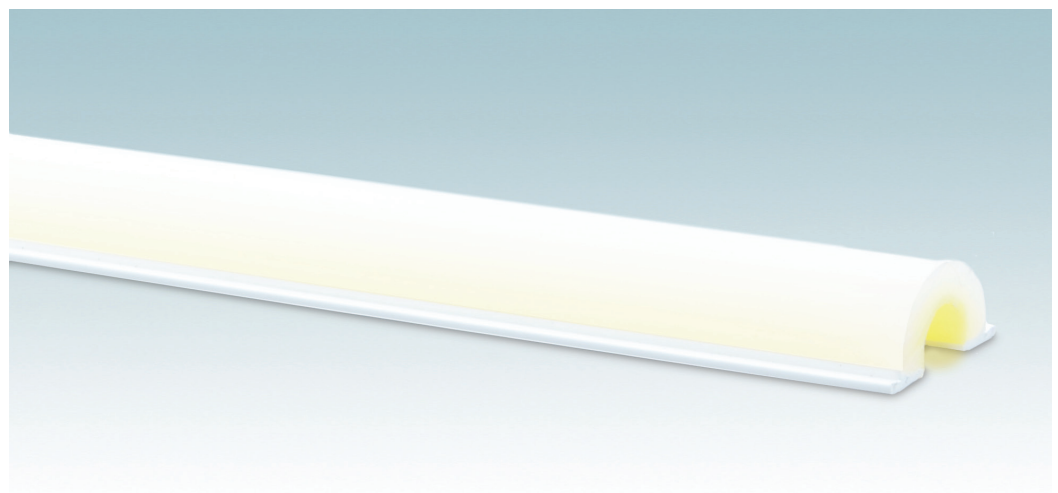

# TABLE OF CONTENTS

Product Nomenclature	3
Minor Product Change Policy	3
Optical Characteristics	4
Performance Characteristics	4
Color Binning Information	5
Relative Spectral Power Distribution	6
Intensity Distribution Diagrams	6
Performance Characteristics Over Wavelength	7
Relative CRI Shift Over Wavelength	8
Relative Conversion Efficacy Over Temperature	8
Absolute Maximum and Minimum Ratings	9
Mechanical Characteristics	9
Reliability and Environmental Ratings	10
Handling Considerations	10
Company Information	10

## Product Nomenclature

ChromaLit Linear products are identified by the following product nomenclature:

### Product order code

CL - ABC - DEFGH - IJK - LMNPQ

#### **Where:**

CL - Designates the ChromaLit product family

A - Designates first digit in CRI

8 = 80 CRI minimum, 9 = 90 CRI minimum

BC - Designates the first two digits in CCT

30 = 3000K, 40 = 4000K, etc.

DEF - Designates shape

LIN = ChromaLit Linear profile

GH - Profile identification number

01 = 2500 lm/ft maximum, 16mm OD round, 8mm ID, 20mm wide flange

IJK - Designates material and mechanical configuration

LMNP - Designated product length in mm

Q - Designates cut tolerance

R = Rough cut, tolerance is -0/+6.4 mm (-0 / +0.25")

#### **Example:**

CL-840-LIN01-PC0-1220R: ChromaLit Linear, profile 1, 80CRI, 4000K CCT, polycarbonate, 1220 mm length, rough cut

## Minor Product Change Policy

The rigorous qualification testing of ChromaLit products ensures product performance. Slight cosmetic changes which do not affect the form fit or function of the product may occur as Intematix continues product optimization.

## Optical Characteristics

For use with blue pump LEDs, reference operation at 25°C.

Product	Description	Nominal CCT <sup>1</sup> (K)	Color Consistency <sup>2</sup> (SDCM)	Min CRI <sup>1,4</sup>	Minimum CE <sup>3</sup> (Lm/W <sub>rad</sub> )	Typical CE <sup>3</sup> (Lm/W <sub>rad</sub> )
CL-927-LIN01-PC0	Linear remote phosphor system, white off-state appearance	2700	3	90	160	170
CL-830-LIN01-PC0	Linear remote phosphor system, white off-state appearance	3000	3	80	200	210
CL-930-LIN01-PC0	Linear remote phosphor system, white off-state appearance	3000	3	90	170	180
CL-835-LIN01-PC0	Linear remote phosphor system, white off-state appearance	3500	3	80	205	215
CL-840-LIN01-PC0	Linear remote phosphor system, white off-state appearance	4000	3	80	210	220
CL-850-LIN01-PC0	Linear remote phosphor system, white off-state appearance	5000	4	80	210	220

## Performance Characteristics

Product	Nominal CCT <sup>1</sup> (K)	Min CRI <sup>1,4</sup>	Typical CE <sup>3</sup> (Lm/W <sub>rad</sub> )	Typical Performance <sup>5</sup>		Maximum Recommended Performance <sup>6</sup>	
				Blue power per ft. (305mm) W <sub>rad</sub>	White lumens per ft. (305mm) lm	Blue power per ft. (305mm) W <sub>rad</sub>	White lumens per ft. (305mm) lm
CL-927-LIN01-PC0	2700	90	170	5.7	970	12.0	2040
CL-830-LIN01-PC0	3000	80	210	5.7	1200	12.0	2520
CL-930-LIN01-PC0	3000	90	180	5.7	1030	12.0	2160
CL-835-LIN01-PC0	3500	80	215	5.7	1225	12.0	2580
CL-840-LIN01-PC0	4000	80	220	5.7	1250	12.0	2640
CL-850-LIN01-PC0	5000	80	220	5.7	1250	12.0	2640

### Notes

- Reference Operation** values included in the table above assume use of the ChromaLit Linear product in a specific reference design. Please refer to application notes for details on the reference design and operational guidelines. Intematix maintains a tolerance of  $\pm 7\%$  on luminous flux and radiant watt measurements. CRI values are minimums.
- Color Consistency** is defined as variation from part to part, color over angle within a part from -90 to +90 degrees from the vertical axis part, and over the length of the product. Color consistency is dependent on the average dominant wavelength of blue LEDs. ChromaLit will achieve the color consistency values indicated in the table above with uniform blue LED average dominant wavelength. 2.5nm ( $\pm 1.25$ nm) of average blue LED wavelength variation will provide 4 SDCM of color consistency for 2700K, 3000K, 3500K and 4000K products and 5 SDCM for 5000K products. 5nm ( $\pm 2.5$ nm) of average blue LED dominant wavelength variation will provide 5 SDCM of color consistency for 2700K, 3000K, 3500K and 4000K products and 6 SDCM for 5000K products. Values are approximate; please refer to the ChromaLit binning diagram for exact bin definition.
- Conversion Efficacy** is the luminous flux (white light) output per radiant watt of blue light input to ChromaLit. W<sub>rad</sub> is the radiometric power measured in Watts. Conversion efficacy is rated based on reference operation and dominant blue LED wavelength of 455nm (peak wavelength of 450nm) at 25°C. To calculate the white light generated multiply the blue radiant output of the blue pump by the conversion efficiency value. To calculate the white efficacy (lumens per Watt) multiply the conversion efficiency by the wall plug efficiency (WPE) of the blue pump used under the rated use conditions or divide the white lumens by the electrical power consumed by the blue pump under operating conditions.
- Minimum CRI** rating is based on reference design using blue LEDs with average dominant wavelength of 455nm. Blue LED populations with an average wavelength shorter than 455nm may result in CRI's below specified values.
- Typical Performance** ChromaLit Linear has been designed with the objective of delivering 1250 lumens per linear foot at 4000K 80 CRI. Based on the conversion efficiency of the phosphor this requires a typical blue pump engine generating 5.7 W<sub>rad</sub> per linear foot. As conversion efficiency varies with CCT and CRI, lumen per foot values for other CCT and CRI products options will vary.
- Maximum Recommended Performance** ChromaLit Linear has been designed to deliver up to 2500 lumens per linear foot at 4000K 80 CRI. Based on the conversion efficiency of the phosphor this requires a typical blue pump engine generating 12.0 W<sub>rad</sub> per linear foot. As conversion efficiency varies with CCT and CRI, lumen per foot values for other CCT and CRI product options will vary. This maximum recommended performance is primarily based on thermal limitations at the system design level. It is possible to achieve higher lumen density values with careful attention to system thermal management considerations. For assistance, please contact the Intematix applications engineering team.

## Color Binning Diagram

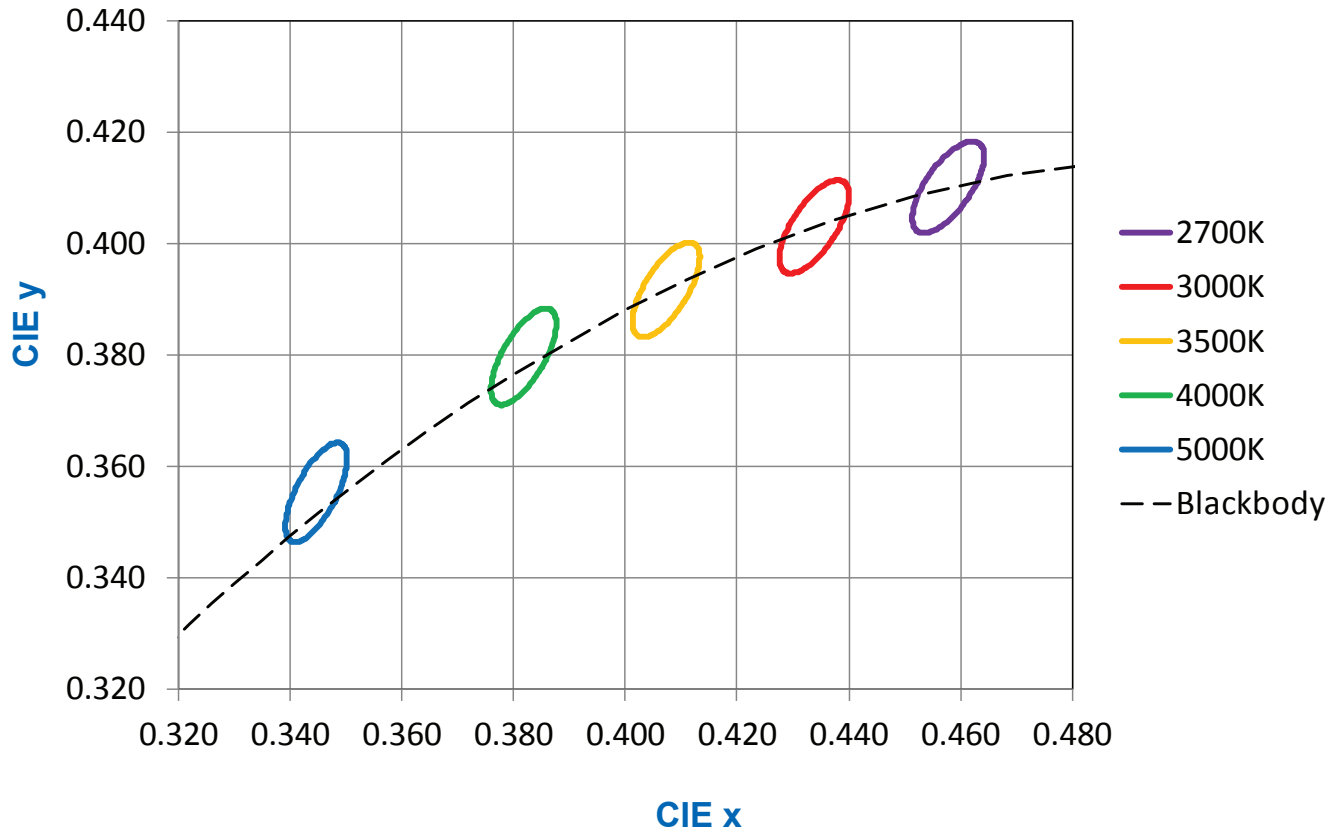

## Color Bin Center Points

Nominal CCT (K)	x	y
2700	0.4578	0.4101
3000	0.4338	0.4030
3500	0.4073	0.3917
4000	0.3818	0.3797
5000	0.3447	0.3553

## Relative Spectral Power Distribution

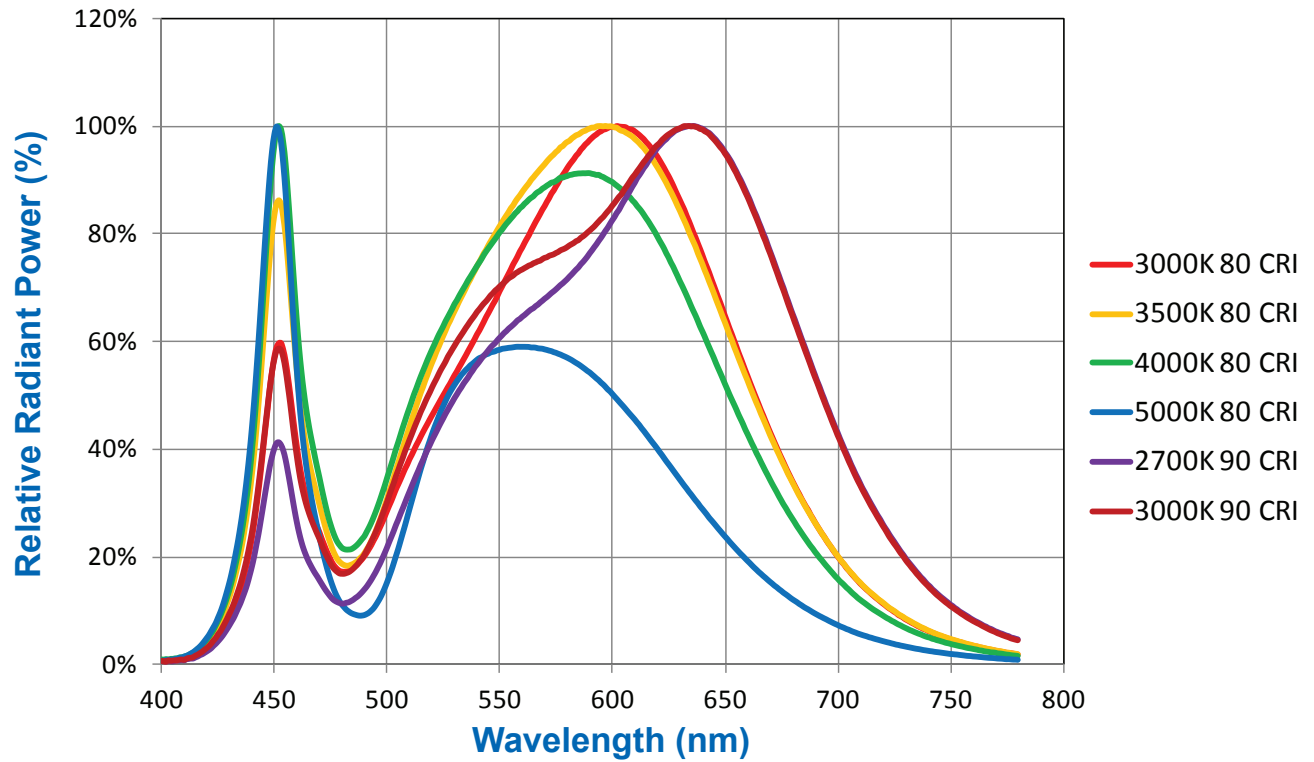

## Intensity Distribution

### Luminous Intensity Distribution Diagrams

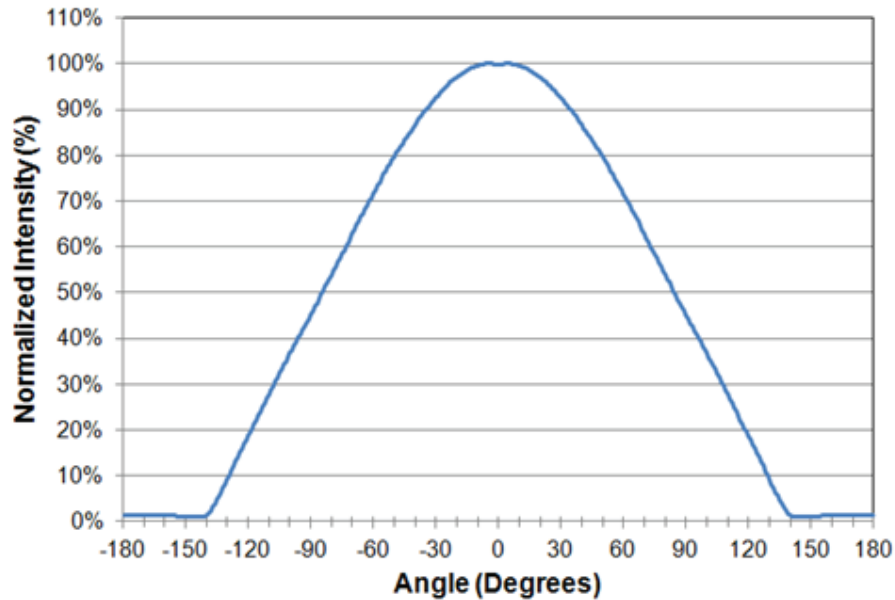

FWHM (Full Width Half Maximum) Beam Angle is 170°

## Luminous Intensity Polar Distribution Diagram

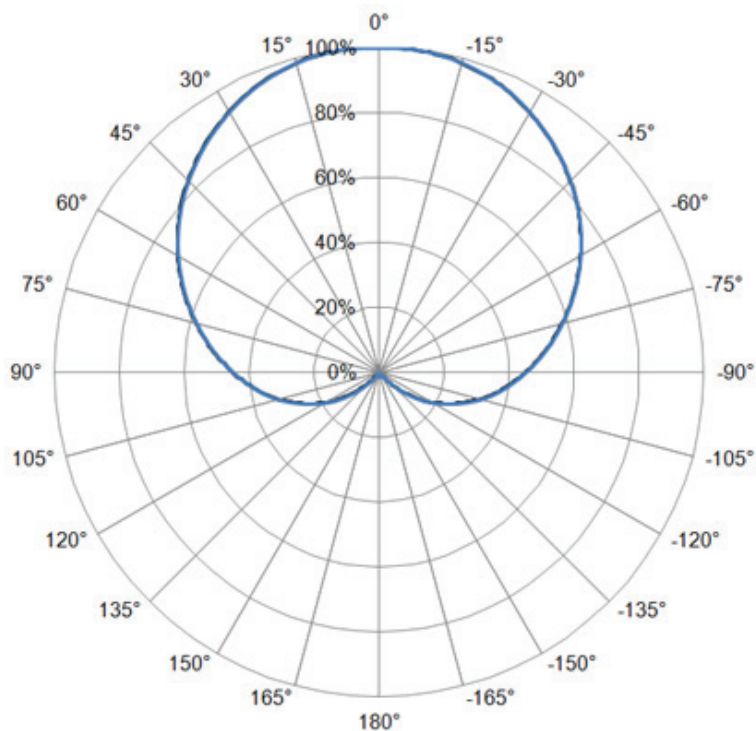

## Performance Characteristics Over Wavelength

### Relative Conversion Efficacy Over Wavelength

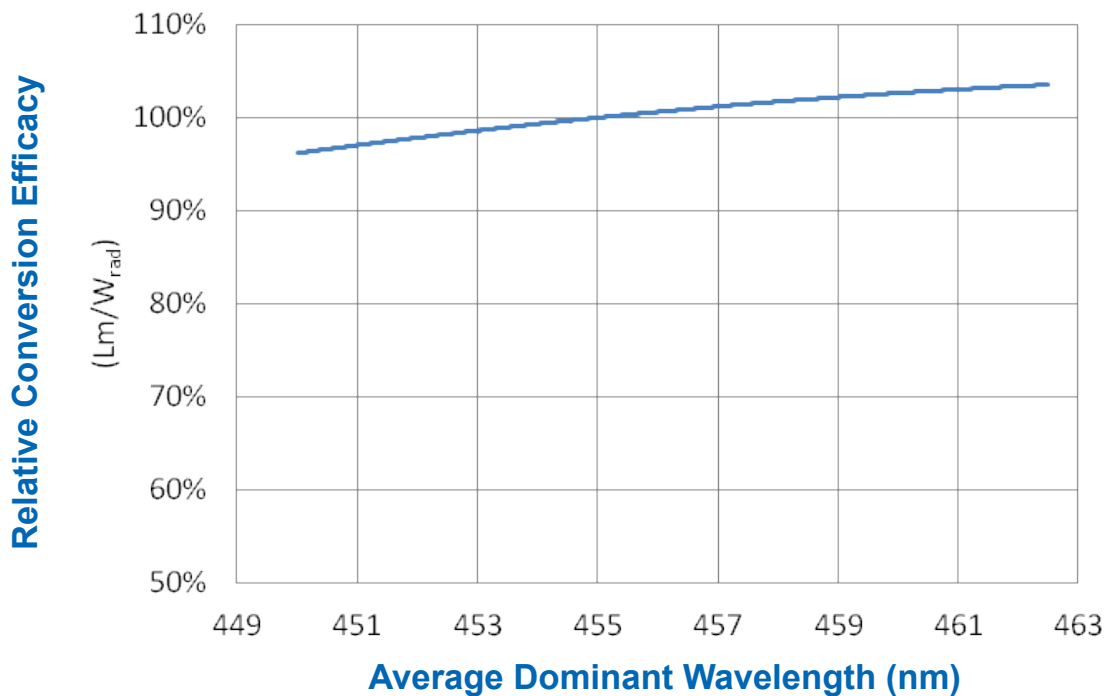

Note: Relative conversion efficacy does not reflect performance of blue LED over dominant wavelength.

## Relative CIE Chromaticity Shift Over Wavelength

	Average Dominant Wavelength				
	450nm	452.2nm	455nm	457.5nm	460nm
$\Delta$ CIE X Coordinate	-0.003	-0.002	0	0.001	0.001
$\Delta$ CIE Y Coordinate	-0.014	-0.007	0	0.005	0.008

## Relative CRI Shift Over Wavelength

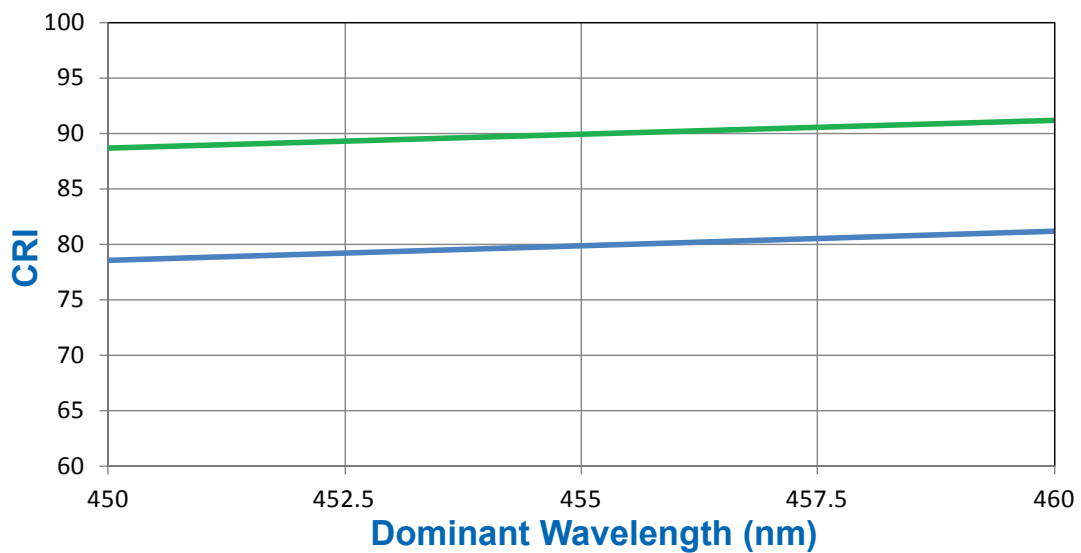

## Relative Conversion Efficacy over Temperature

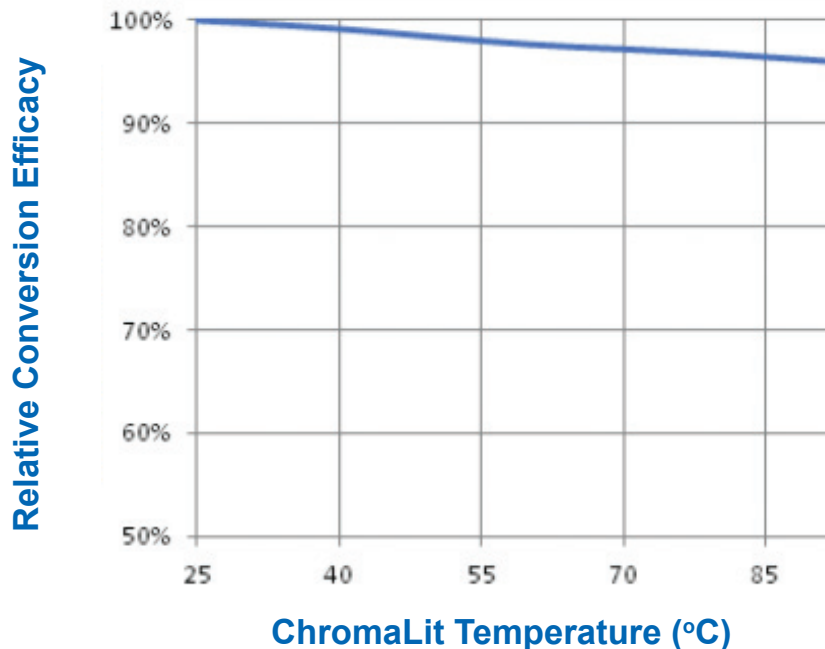



## Absolute Maximum and Minimum Ratings

Description	Maximum and Minimum Values
Maximum operating temperature (Tmax <sup>1</sup> )	90°C
Minimum operating temperature	-40°C
Maximum storage temperature	90°C
Minimum storage temperature	-40°C
Response time to full light output	10µs

<sup>1</sup> Tmax is the maximum temperature measured on the inner surface of ChromaLit. Please consult application notes for additional information on measurement location.

## Mechanical Characteristics

ChromaLit Linear is delivered in 4-foot (1220 mm) rough cut lengths. The tolerance on the rough cut is defined as -0 / +6.4 mm (-0 / +0.25 inches). This allows for the lighting manufacturer to trim the product to exact length as required for the application to ensure optimal performance. Custom cut and precision cut lengths with smaller cut tolerances are available on demand. Please contact your Intematix sales representative for further information.

## ChromaLit Linear Mechanical Diagram LIN01 Profile

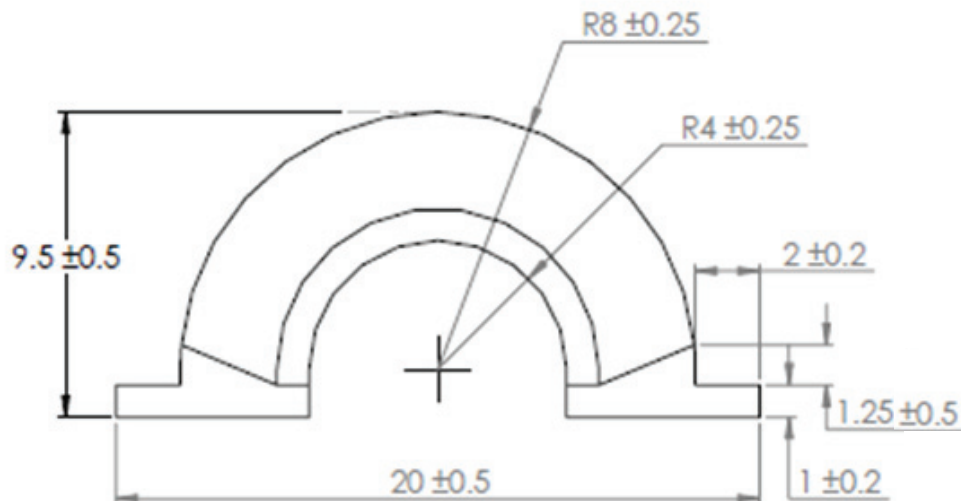

### Notes

1. Drawings are not to scale.
2. Drawing dimensions are in millimeters.
3. Flatness in the linear direction is maintained to a tolerance of 2.7 mm per linear meter (0.032 inches per linear foot).

## Reliability and Environmental Ratings

Description	Typical Values
Temperature / Humidity (non-condensing)	60°C 90% RH
Coefficient of Thermal Expansion	70 ppm / °C
Flame Rating <sup>1</sup>	HB
RoHS	RoHS Compliant
REACH	REACH Compliant

<sup>1</sup> Flame rating indicated based on UL rating of bulk material used for ChromaLit Linear. Flammability is dependent on both material and geometry and ChromaLit Linear has been tested to exceed higher flammability ratings in finished lighting products. V0 rated versions available upon request - please contact your Intematix sales representative for additional details.

## Handling Considerations

Since a dirty or damaged phosphor layer could result in alteration in product performance, ChromaLit Linear should be handled similarly to most optical components. It is best to handle the parts at the edges and prevent mechanical abrasion. If epoxies are used, they must be kept off of the entrance or exit apertures of ChromaLit, since they could greatly impact performance. If parts require cleaning, use a lint free tissue, isopropanol (IPA), or mild detergent. Dry using compressed air (CDA).

---

## About Intematix

Intematix develops essential phosphor materials to drive the LED lighting revolution. The company's comprehensive range of products and solutions can be used to build foundations for the world's LED lighting products and systems including general lighting, displays, automotive and many others. A broad selection of products and innovative delivery systems accelerate time-to-market, improve light quality and efficacy and reduce costs. To learn more about the company, please visit [www.intematix.com](http://www.intematix.com).

**INTEMATIX**

46430 Fremont Boulevard ● Fremont, CA 94538

Tel: +1 510.933.3300 ● Fax: +1 510.668.0793

[sales@intematix.com](mailto:sales@intematix.com)

[www.intematix.com/ChromaLitLinear](http://www.intematix.com/ChromaLitLinear)